



## MEDİKAL ÜRÜN KATALOĞU





T.C.  
İlaç ve Tıbbi Cihaz  
Ulusal Bilgi Bankası



No: 2667269036717



# ÖNSÖZ

Sektöründe ileri ve yeni teknolojiye sahip endüstriyel mutfak ekipmanlarını üreten, geliştiren, pazarlayan ve sektörünün lideri bir şirket olan Öztiryakiler Madeni Eşya Sanayi ve Ticaret A.Ş. Ağustos 2010 tarihinden itibaren medikal ve Sanitar projelerde de komple çözüm önerileri üretmektedir.

OZTI-Medical Markası ile paslanmaz çelikten ameliyathane, yoğun bakım, servis ekipmanı şeklinde medikal ürünler, sürgü ve terlik sabo yıkama makinaları, morg odası cerrahi alet yıkama ve dezenfeksiyon makinaları, laboratuvar aletleri ile diş aletleri yıkama makineleri bebek emzik ve biberon yıkama makineleri üretmektedir.

Ayrıca sektörünün seçkin markaları arasından negatoskoplar, buharlı ve formaldehitli sterilizatörler, çift kapılı hijyenik bariyerli çamaşır yıkama- sıkma makinesi, çamaşır kurutma makineleri ve hastaneler için tasarlanmış silindir tip ütü ithal etmektedir.

Yine OZTI-Medical Markası ile Ameliyat Masaları, Ameliyat Lambaları, Anestezi Cihazları, Hasta başı Monitörleri, Defibrillatör, Elektrokoter, Cerrahi Aspiratör, Ameliyathane Pendantı, İnfüzyon Pompası şeklinde Ameliyathane Ürünleri ile Acil Destek Arabası, Fetal & Maternal onitör, EKG Cihazları, Cerrahi Aspiratör, 4 Motorlu Hasta Karyoları şeklinde Hastane Teçhizatları temin ve tedarik etmektedir. Öztiryakiler Madeni Eşya Sanayi ve Ticaret A.Ş., Sağlık işletmelerinin mimari tasarımı ve medikal ekipman seçimi üzerinde uzman kadrosu ile Hastane, Acil servis, Ameliyathane, Yoğun bakım, Ara yoğun bakım, Servis odalarının Projelendirilmesi noktasında da Danışmanlık, Fizibilite Hazırlanması, Proje Çizimi, Teknik Alt Yapılandırması, Cihaz Seçimi ve Temini, Montaj Hizmetleri, Teknik Servis Hizmetleri şeklinde faaliyetlerde de bulunmaktadır.

ÖZTİRYAKİLER MADENİ EŞYA SANAYİ ve TİCARET A.Ş. Medikal ve Sanitar ürünlerinde sağlık sektöründe hastane enfeksiyoları özelinde önem arz eden önemini koruyan mikrobiyal bulaşmaları minimize edecek nanoteknolojik aseptik yüzeylere sahip ürünler yapmaya yönelmiştir.

Islak hacim alanında da kombi setler paslanmaz çelikten kağıt vericiler çöp kovaları lavabolar, üretimi yapmaktadır ayrıca corian malzemedeki tezgah laminant kabin sistemleri tasarlamaktadır. AVM Otel projeleri için saç kurutma makineleri el kurutmalar sıvı sabunluklar ithal edip yine ileri nano teknolojik kaplama ile günümüz tasarımlarına komple çözümler üretmektedir.

## **POLİTİKAMIZ**

Toplam Kalite Yönetimi ilkelerine uymak. Müşteri isteklerini kusursuz karşılamak. Her birim ve üründe verimli eğitim programları uygulamak. Modern üretim tekniklerini kullanarak üretim yapmak. Tasarım ve ARGE faaliyetlerini sürdürmek. Etkin pazar araştırmaları yapmak. Yenilikleri bulmak, imalatlarını ve/veya ithalatlarını yaparak piyasaya sunmak.

## **ÜRÜNLERİN KULLANIM AMAÇLARI**

Sağlığa zarar verecek ortamlardan korunmak için yapılacak uygulamalar ve alınan önlemlerin tümü hijyen olarak tanımlanır. Ürünlerimiz; ev, işyeri, otel, sağlık kurumu, plaza, alışveriş merkezleri ve diğer binalarda olmak üzere; banyo, tuvalet, mutfak, yemekhane, vb. gibi hijyenlik gereken ortamlarda kullanılmaktadır. Ortamların hijyenliği temizlikle, temizlikleriniz ürünlerimizle sağlanacaktır.

## **PASLANMAZ ÇELİK ÖZELLİKLERİ**

Paslanmaz çelik hijyen ekipmanlarımız; paslanmaz çeliğin bakteri barındırmayan özelliği ile üretilmiş son derece sağlıklı ve kolay temizlenen ürünlerdir.

Paslanmaz çelikler, bileşiminde düşük karbon (C) ve yüksek oranlarda krom (Cr) ve nikel (Ni) içeren çelik alaşımlarıdır.

Paslanmaz çeliklerde bünyede bulunan krom, havada bulunan oksijen ile hızlı bir oksidasyona girerek yüzeyde ince bir oksit tabakası oluşturur. Bu da geride kalan çeliğin oksitlenmesini önleyen bir katman vazifesi görür. Bu suretle çelik, paslanmazlık özelliği kazanır.

## **PASLANMAZ ÇELİK TEMİZLİĞİ**

Ürünler paslanmaz çelikten imal edildiği için temizliğinin sadece duru ve yumuşak bir bez ile yapılması gerekmektedir.

Temizlik işlerinde ürünlerin çizilmesini önlemek için sert ve aşındırıcı maddeler, alüminyum tel, çelik yün vb. gibi malzemeler kullanmayınız. Gövdelere işleyen kirlerde kaliteli bir çelik parlatici kullanabilirsiniz, ancak, paslanmaz çelikler, asitlerin etkilenmektedir. Temizlik için; proseslerinde asit veya klorür içeren kimyasal maddeleri (tiner, çamaşır suyu vb.) kesinlikle kullanmayınız. Proseslerinde asit veya klorür içeren kimyasallar ile temizlik yapıldığında paslanmaz çeliklerin tamamında korozyon meydana gelebilmektedir. Solventlerin tamamına yakını klorür içerir.

## **ÜRÜNLERİN GARANTİSİ**

Ürünlerimiz; kullanım hatası olmaması ve yetkili elemanlar dışındaki şahıslar tarafından onarım ve başka bir nedenle müdahale edilmemiş olması şartıyla, ürünlerin bütün parçaları dahil olmak üzere malzeme, işçilik, montaj ve üretim hatalarına karşı 2 yıl süre ile garantimiz altındadır. Ürünün tamir süresi en fazla 30 (otuz) iş günüdür. Arıza müracaatları, malın satış belgesi ile birlikte yapılmalıdır. Ürün arızaları hakkındaki raporlar, sadece merkezimiz teknik elemanları, hammadde temin kaynakları ve servislerimiz tarafından verilir.

# İÇİNDEKİLER / INDEX

## Sf. ŞİRKET PROFİLİ

- 1 Önsöz / Preface
- 2 Hakkımızda / Our Profiles
- 3 Tanıtım / Presentation
- 4 Belgeler / Certificates

## Sf. INOX SAĞLIK GEREÇLERİ

- 9 "INOX" Lavabo Setleri / Wash Basin Sets
- 10 "INOX" Ayaklı Lavabo Sistemleri / Wash Basin Systems
- 11 "INOX" Boy Lavabo Setleri / Long Wash Basin Sets
- 12 "INOX" Fotoselli Lavabo Setleri / Wall Assembly Sets
- 13 "INOX" Ameliyathane Lavabo Sistemleri / Wash Basin Sets
- 14 "INOX" Sanitar Ürünler / Sanitary Products
- 15 "INOX" Alaturca WC / Sanitary Products
- 16 "INOX" Pisuar, Duş Teknesi / Urinals & Shower Tray

## Sf. INOX TEZGAHLAR

- 19 "INOX" Çalışma Tezgahları / Work Counters
- 20 "INOX" Çalışma Tezgahları / Work Counters
- 21 "INOX" Evyeli Tezgahlar / Basin Counters
- 22 "INOX" Yıkama Tezgahları / Washing Counters
- 23 "INOX" Yıkama Tezgahları / Washing Counters
- 24 "INOX" Fonksiyonel Tezgahlar / Function Counters
- 25 "INOX" Fonksiyonel Tezgahlar / Function Counters
- 26 "INOX" Sedyeler / Stretchers
- 27 "INOX" Sedyeler / Stretchers
- 28 "INOX" Sedyeler / Stretchers

## Sf. INOX DOLAPLAR

- 31 "INOX" Medical Dolaplar / Cabinets
- 32 "INOX" Medical Dolaplar / Cabinets
- 33 "INOX" Dolap ve Çalışma Tezgahları / Cabinets & Counters
- 34 "INOX" Arabalar / Trolleys
- 35 "INOX" Arabalar / Trolleys
- 36 "INOX" Arabalar / Trolleys
- 37 "INOX" Hijyen Ekipmanlar / Hygienic Equipments
- 38 "INOX" Kan Muhafaza Dolapları / Blood Refrigerators
- 39 "INOX" Kan Muhafaza Dolapları / Blood Refrigerators
- 40 "INOX" Morg Dolapları / Mortuary Cabinets

## Sf. INOX RAF ve SERVİS SİSTEMLERİ

- 43 "INOX" Raf ve Basamaklar / Rack & Steps
- 44 "INOX" Raf Sistemleri / Shelving Systems
- 45 "INOX" PortaShelf Raf Sistemleri / Shelving Systems
- 46 "INOX" Taşıma Sistemleri / Moving Trolleys
- 47 Thermotrans Taşıma Kapları
- 48 Servis Elemanları / Service Equipments

## Sf. DİSPENSER ve ARMATÜR

- 51 Sterilizasyon / Sterilization
- 52 Dezenfektan Ürünleri / Disinfection Unit
- 53 "INOX" Sabun Dispenserleri / Soap & Foam Dispensers
- 54 "INOX" Kağıt Dispenserleri / Paper Dispenser
- 55 El/Yüz/Saç Kurutma Makineleri / Dryer Machines
- 56 Fotoselli Musluklar / Automatic Taps
- 57 Fotoselli Musluklar / Automatic Taps
- 58 Pedallı Musluk Sistemleri / Pedal Taps

## Sf. INOX AKSESUAR ve KOVA

- 61 "INOX" Aksesuarlar / Accessories
- 62 "INOX" Ameliyathane Aks. / Operating Accessories
- 63 "INOX" Serum Askıları / Drip Stands
- 64 "INOX" Tabureler / Chairs
- 65 "INOX" Ayna sistemleri / Mirror Systems
- 66 "INOX" Engelli Aksesuarları / Disabled Accessories
- 67 "INOX" Engelli Aksesuarları / Disabled Accessories
- 68 "INOX" Çöp Kovaları / Waste Bins
- 69 "INOX" Tekerlekli Kovalar / Waste Bins
- 70 "INOX" Tekerlekli Arabalar / Trolleys
- 71 "INOX" Torbalı Arabalar / Trolleys

## Sf. NOTLAR

- 72 Notlar / Notes



# INOX SAĞLIK GEREÇLERİ



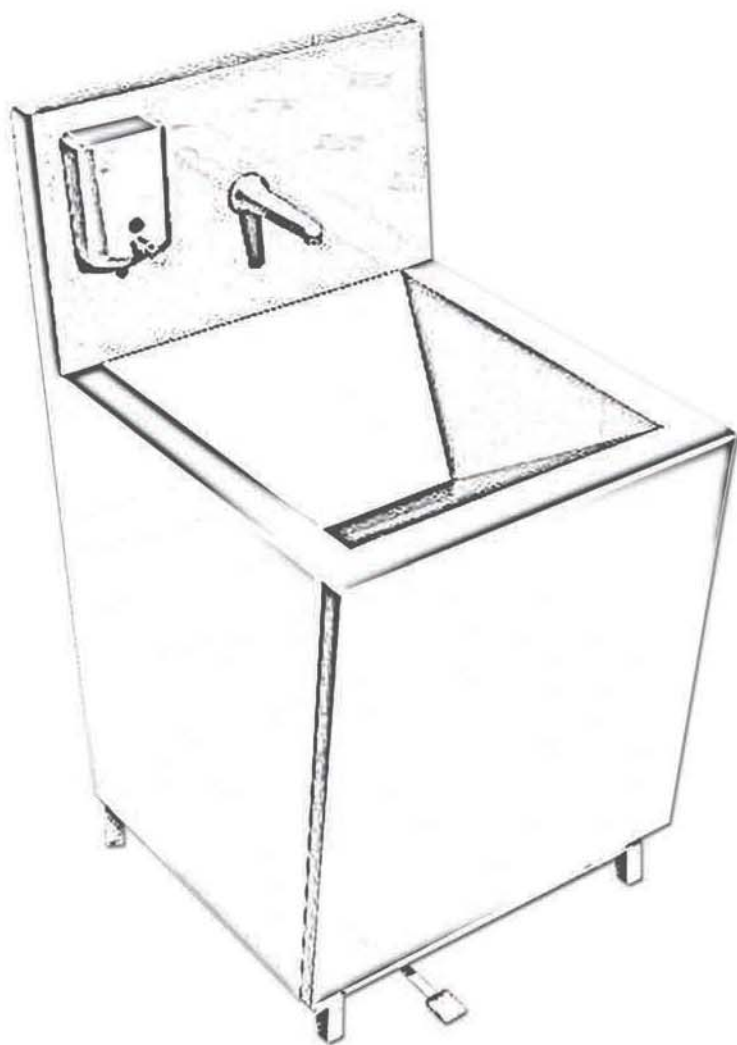



## “INOX” Lavabo Setleri / Wash Basin Sets



▲  
**Diz Kumandalı Arkalıklı**  
*Kapalı Küçük Lavabo Seti*  
Knee Operated Basin Set  
33x40x23 cm.

**Kod**  
01.40332.30 Musluksuz (W/out Tap)  
01.40332.31 Musluklu (With Tap)



▲  
**Diz Kumandalı Kapalı**  
*Büyük Lavabo Seti*  
Knee Operated Large Basin Set  
40x50x23 cm.

**Kod**  
01.50393.92 Musluksuz (W/out Tap)  
01.50393.90 Musluklu (With Tap)



▲  
**Diz Kumandalı Kapalı Arkalıklı**  
*Büyük Lavabo/Evye Seti*  
Knee Operated Large Basin Set  
50x60x50 cm.

**Kod**  
01.056A0.92 Musluksuz (W/out Tap)  
01.056A0.90 Musluklu (With Tap)



▲  
**Çift Katlı Ayaklı Kapalı Lavabo Seti**  
*Two Layered Basin Set*  
(Paspas yıkama evyesi)  
70x50x90 cm.  
**Kod: 01.50709.00**

# “INOX” Ayaklı Lavabo Sistemleri / Wash Basin Systems



▲ **Tekli Kapalı Lavabo Seti**  
Single Basin Set

45x40x80/120 cm.

Kod

02.A4540.00 Musluksuz (W/out Tap)  
02.A4540.20 Pedallı Musluklu (With Pedal Tap)



▲ **Çiftli Kapalı Lavabo Seti**  
Double Basin Set

90x40x120 cm.

Kod

02.A9040.00 Musluksuz (W/out Tap)  
02.A9040.20 Pedallı Musluklu (With Pedal Tap)



▲ **Tekli Kapalı Lavabo Seti**  
Single Basin Set

45x40x80 cm.

Kod

02.A1200.00 Musluksuz (W/out Tap)  
02.A1200.20 Pedallı Musluklu  
(With Pedal Tap)



▲ **Tekli Kapalı Lavabo Seti**  
Single Basin Set

45x40x80 cm.

Kod

12.A1210.40 Bas Musluklu  
(Push Button Tap)



▲ **Tekli Kapalı Lavabo Seti**  
Single Basin Set

45x40x80 cm.

Kod

02.A1210.00 Musluksuz (W/out Tap)  
02.A1210.20 Bas Musluklu  
(With Pedal Tap)

# “INOX” Boy Lavabo Setleri / Long Wash Basin Sets

## Boy Lavabo Seti

Long Basin Set

60/90/120/150/180/210 cm.  
boylarında üretim imkanı.  
(Abdestlik)  
Aynalı

Kod: 02.A0900.00



## Boy Lavabo Seti

Long Basin Set

Set üstü musluk bağlanabilir.  
60/90/120/150/180/210 cm.  
boylarında üretim imkanı.  
(Abdestlik)

Kod: 02.A0600.00

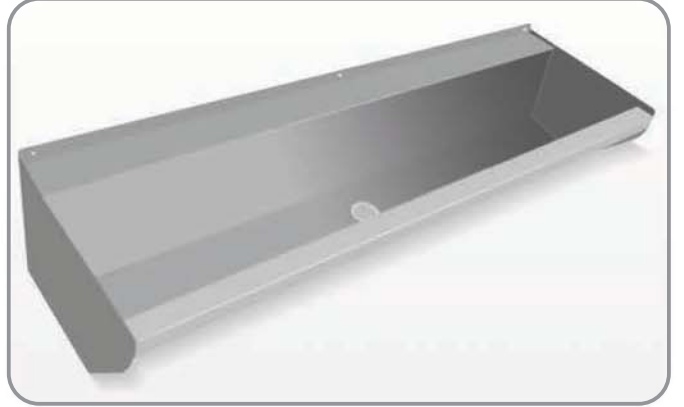

## Boy Lavabo Seti Rondo Lavabo Montajlı

Long Basin Set

60/90/120/150 cm.  
boylarında üretim imkanı.  
Aynalı

Kod: 02.A0800.00



## Kapalı Çiftli Lavabo Seti

Closed Double Basin Set

95x44x15 cm.  
Gizli su gideri.

Kod: 02.A7044.30



## Kapalı Lavabo Seti

Closed Basin Set

70x44x15 cm.  
Gizli su gideri.

Kod: 02.A7044.00

# “INOX” Fotoselli Lavabo Setleri / Wall Assembly Sets



## ◀ Duvara Asma Tekli Lavabo Sistemi

Wall Assembly Single Basin Set

Ankastre fotoselli musluk sistemli.  
50x60x90 cm.

Kod: 02.05060.90



## ◀ Duvara Asma Çiftli Lavabo Sistemi

Wall Assembly Double Basin Set

Ankastre fotoselli musluk sistemli.  
95x60x90 cm.

Kod: 02.09560.90



## ◀ Duvara Asma Üçlü Lavabo Sistemi

Wall Assembly Triple Basin Set

Ankastre fotoselli musluk sistemli.  
140x60x90 cm.

Kod: 02.14060.90

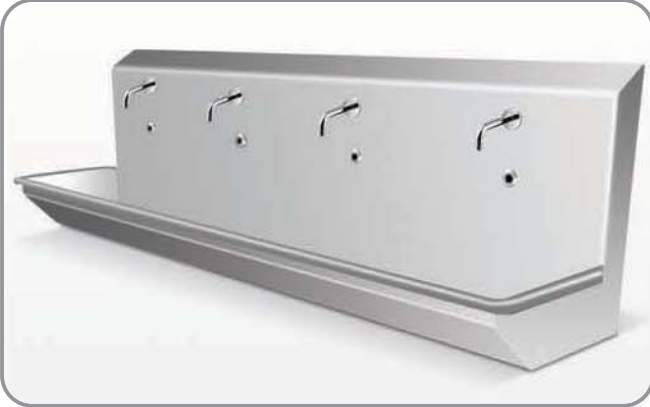

## ▲ Duvara Asma Dörtlü Lavabo Sistemi

Wall Assembly Quartet Basin Set

Ankastre fotoselli musluk sistemli.  
180x60x90 cm.

Kod: 02.18060.90



## ▲ Duvara Asma Çiftli Lavabo sistemi

Wall Assembly Double Basin Set

Ankastre sıcak/soğuk  
fotoselli musluk sistemli.  
95x60x90 cm.

Kod: 02.09560.80

# “INOX” Ameliyathane Lavabo Sistemleri / Wash Basin Sets

## Çiftli, Arkalıklı Ameliyathane Lavabo Seti

Double Basin Set For Operating Room

90x40x125 cm.

Kod

02.A9040.20

02.A9040.22

02.A9040.24

Musluksuz (W/out Tap)

Pedallı Musluklu (With Pedal Tap)

Fotoselli Musluklu (With Photo Celled Tap)



## Tekli, Arkalıklı Ameliyathane Lavabo Seti

Single Basin Set For Operating Room

Fotoselli sıvı sabunluklu.

45x40x125 cm.

Kod

02.A1201.10 Musluksuz (W/out Tap)

02.A1201.12 Pedallı Musluklu (With Pedal Tap)

02.A1201.14 Fotoselli Musluklu (With Photo Celled Tap)



## Üçlü, Arkalıklı Ameliyathane Lavabo Seti

Triple Basin Set For Operating Room

Basmalı batıcon otomati, fırçalık opsiyonel.

180x60x130 cm.

Kod

02.A9060.60 Musluksuz (W/out Tap)

02.A9060.62 Pedallı Musluklu (With Pedal Tap)

02.A9060.64 Fotoselli Musluklu (With Photo Celled Tap)



# “INOX” Sanitar Ürünler / Sanitary Products



## ◀ “Klozet” Alafranga W.C.

WC

Alttan/arkadan çıkışlı  
40x42x54 cm.  
(Klozet kapağı hariç.)

Kod: 21.B0140.00



## ◀ “Asma Klozet” Alafranga W.C.

WC

Arkadan çıkışlı.  
36x56x38 cm.

Kod: 22.B0141.00



## ▲ “Klozet” Alafranga W.C.

WC

Alttan/arkadan çıkışlı  
40x42x55 cm.  
(Klozet kapağı hariç.)

Kod: 21.B0135.00



## ▲ “Klozet+Rezervuar” Alafranga W.C.

WC With Cistern

Alttan/arkadan çıkışlı  
40x42x54 cm.  
(Klozet kapağı hariç.)

Kod: 22.B0144.00

## “INOX” Alaturka WC / Sanitary Products

### Kombi ▶

Combi (Shower Tray + Alaturca WC)

Alaturca W.C.: 55x65 cm.

+

Duş Teknesi: 80x80 cm.

Kod: 01.B0500.00

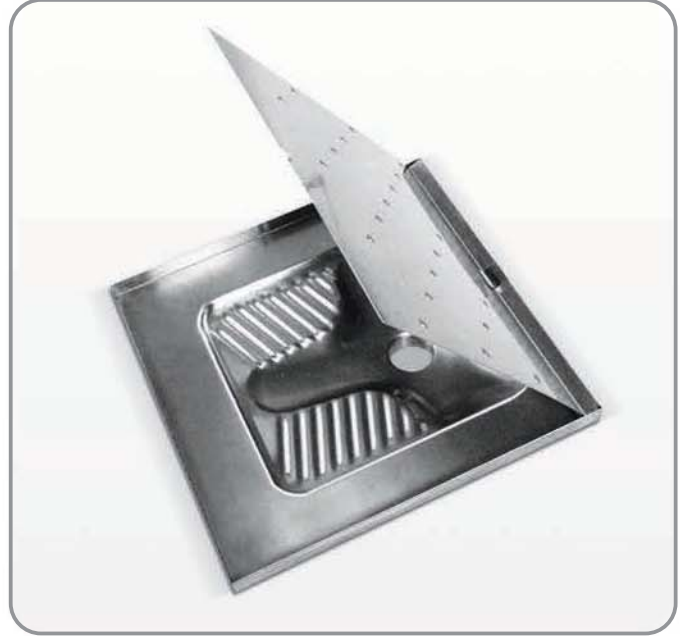

### Alaturka WC ▶

Alaturca WC

63x65x23 cm.

Kod: 67.59112.00



### Alaturka W.C. ▶

Alaturca WC

50x60 cm.

Kod: 23.B0507.10



## “INOX” Pisuar, Duş Teknesi / Urinals & Shower Tray



◀ **Pisuar**  
Urinal  
*Lux sifon sistemli*  
30x30x48 cm.  
Kod: 22.BM155.00



◀ **Pisuar**  
Urinal  
*S borulu sifon sistemli.*  
30x35x49 cm.  
Kod: 03.BM150.00



◀ **Duş Teknesi**  
Shower Tray  
75x75x12 cm.  
Kod: 23.B00508.00



# INOX TEZGAHLAR



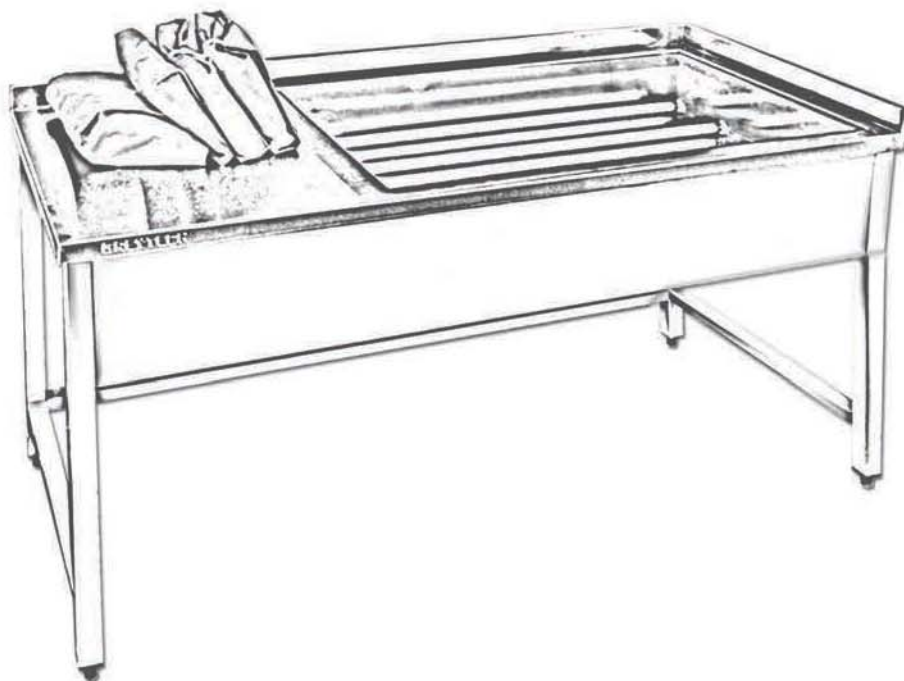

# “INOX” Çalışma Tezgahları / Work Counters

## Taban Rafsız Çalışma Tezgahı ▶

Work Counter W/out Bottom Shelf

Kod	Ölçü
08.12060.00	60x120x85 cm.
08.12070.00	70x120x85 cm.
08.14060.00	60x140x85 cm.
08.14070.00	70x140x85 cm.
08.16060.00	60x160x85 cm.
08.16070.00	70x160x85 cm.
08.19060.00	60x190x85 cm.
08.19070.00	70x190x85 cm.



## Taban Rafli Çalışma Tezgahı ▶

Work Counter With Bottom Shelf

Kod	Ölçü
08.12060.08	60x120x85 cm.
08.12070.08	70x120x85 cm.
08.14060.08	60x140x85 cm.
08.14070.08	70x140x85 cm.
08.16060.08	60x160x85 cm.
08.16070.08	70x160x85 cm.
08.19060.08	60x190x85 cm.
08.19070.08	70x190x85 cm.



## Tek Çekmeceli Çalışma Tezgahı ▶

Work Counter With Bottom Shelf & Single Drawer

Kod	Ölçü
08.12060.20	60x120x85 cm.
08.12070.20	70x120x85 cm.
08.14060.20	60x140x85 cm.
08.14070.20	70x140x85 cm.
08.16060.20	60x160x85 cm.
08.16070.20	70x160x85 cm.
08.19060.20	60x190x85 cm.
08.19070.20	70x190x85 cm.



# “INOX” Çalışma Tezgahları / Work Counters



## ◀ Ara Rafli Çalışma Tezgahı

Work Counter With Double Shelf

Kod	Ölçü
08.12060.04	60x120x85 cm.
08.12070.04	70x120x85 cm.
08.14060.04	60x140x85 cm.
08.14070.04	70x140x85 cm.
08.16060.04	60x160x85 cm.
08.16070.04	70x160x85 cm.
08.19060.04	60x190x85 cm.
08.19070.04	70x190x85 cm.



## ◀ Grup Çekmeceli Taban Rafli Çalışma Tezgahı

Work Counter With Drawers and Bottom Shelf

Kod	Ölçü
08.12060.48	60x120x85 cm.
08.12070.48	70x120x85 cm.
08.14060.48	60x140x85 cm.
08.14070.48	70x140x85 cm.
08.16060.48	60x160x85 cm.
08.16070.48	70x160x85 cm.
08.19060.48	60x190x85 cm.
08.19070.48	70x190x85 cm.



## ◀ Ara Rafli Kapaksız Dolaplı Çalışma Tezgahı

Work Counter With Double Shelf

Kod	Ölçü
08.12060.30	60x120x85 cm.
08.12070.30	70x120x85 cm.
08.14060.30	60x140x85 cm.
08.14070.30	70x140x85 cm.
08.16060.30	60x160x85 cm.
08.16070.30	70x160x85 cm.
08.19060.30	60x190x85 cm.
08.19070.30	70x190x85 cm.



## ◀ Grup Çekmeceli Taban ve Ara Rafli Çalışma Tezgahı

Work Counter With Drawer, Double Shelf

Kod	Ölçü
08.12060.44	60x120x85 cm.
08.12070.44	70x120x85 cm.
08.14060.44	60x140x85 cm.
08.14070.44	70x140x85 cm.
08.16060.44	60x160x85 cm.
08.16070.44	70x160x85 cm.
08.19060.44	60x190x85 cm.
08.19070.44	70x190x85 cm.

# “INOX” Evelyli Tezgahlar / Basin Counters



**Tek Gözlü Sol Damlalıklı Evelyli Tezgah**

*One Bowl Basin Counter*

Kod	Ölçü
08.106A5.11	60X100x85 cm.
08.107E5.11	70x100x85 cm.
08.126A5.11	60x120x85 cm.
08.127C5.11	70x120x85 cm.
08.146E5.11	60x140x85 cm.
08.147D5.11	70x140x85 cm.



**Tek Gözlü Sağ Damlalıklı Evelyli Tezgah**

*One Bowl Basin Counter*

Kod	Ölçü
08.106A5.11	60X100x85 cm.
08.107E5.11	70x100x85 cm.
08.126A5.11	60x120x85 cm.
08.127C5.11	70x120x85 cm.
08.146E5.11	60x140x85 cm.
08.147D5.11	70x140x85 cm.



**Çift Gözlü Evelyli Tezgah**

*Double Bowl Basin Counter*

Kod	Ölçü
08.126E5.27	60x120x85 cm.
08.127C5.27	70x120x85 cm.
08.146E5.27	60x140x85 cm.
08.147C5.27	70x140x85 cm.

**Cerrahi Alet Arabası**

*Surgeon Tool Counter*  
41x90x85 cm.

Kod: 02.T4190.85



**Çift Gözlü Çift Damlalıklı Evelyli Tezgah**

*Two Bowl, Two Drainer Basin Counter*

Kod	Ölçü
08.166A4.23	60x160x85 cm.
08.186E4.23	60x180x85 cm.
08.187C4.23	70x180x85 cm.
08.196E4.23	60x190x85 cm.
08.197C4.23	70x190x85 cm.
08.216E4.23	60x210x85 cm.
08.246E4.23	60x240x85 cm.
08.247D4.23	70x240x85 cm.



**Büyük Göz Evye (Süzme Tezgahı)**

*Large Bowl Basin Counter*

Kod	Ölçü
08.12060.85	60x120x85 cm.
08.12070.85	70x120x85 cm.
08.14060.85	60x140x85 cm.
08.14070.85	70x140x85 cm.
08.16060.85	60x160x85 cm.
08.16070.85	70x160x85 cm.
08.19060.85	60x190x85 cm.
08.19070.85	70x190x85 cm.

# “INOX” Yıkama Tezgahları / Washing Counters



## ◀ Tek Gözlü Damlalıklı Dolaplı Evye Tezgahı

One Bowl, One Drainer Counter Basin  
60x100x85 cm.

Kod: 08.10060.85



## ◀ Izgara Evyeli Alet Yıkama Tezgahı

Grill Bowl Tool Washing Basin

Kod	Ölçü
08.12080.00	80x120x85 cm.
08.14080.00	80x140x85 cm.
08.16080.00	80x160x85 cm.
08.19080.00	80x190x85 cm.



## ◀ Bebek Yıkama Evyesi

Baby Washing Basin  
65x160x110 cm.

Kod: 02.A6516.40



## ◀ Izgara Tablalı Alet Yıkama Evyesi

Grill Plated Tool Washing Basin

Kod	Ölçü
02.A6014.85	60x140x85 cm.
02.A6014.15	60x140x125 cm.

## “INOX” Yıkama Tezgahları / Washing Counters

### Gasil (Otopsi) Masası ▶

Autopsy Table

90X200X85 cm.

Kod: 02.D9020.85



### Gasil (Otopsi) Masası ▶

Autopsy Table

(Batarya Sifon Dahil)

90X250X85 cm.

Kod: 02.D9025.85



### Otopsi Tezgahı ▶

Autopsy Counter With Basin

Evyeli

100X260X75 cm.

Kod: 02.D9526.75



## “INOX” Fonksiyonel Tezgahlar / Function Counters



### ◀ Ay Masa

*Moon Shaped Table*

*Taban Rafli, Tekerlekli.  
169X88 / 46x105 cm.  
Kod: 02.X1688.10*



### ◀ Keten Katlama Masası

*Linen Folding Table With Light  
Aydınlatmalı*

*70x140x85 cm.*

*Kod: 24.06130.00*



### ◀ Paketleme Tezgahı

*Packaging Counter*

*Çekmeceli, Fonks. Standlı  
60x160x85 cm.*

*Kod: 24.06144.A0*



## “INOX” Fonksiyonel Tezgahlar / Function Counters



▲  
**Serum Askılı Muayene Masası**  
*Diagnostic Bed With Drip Stand*  
Kod: 25.70210.85



▲  
**Serum Askılı Cerrah Masası**  
*Operating Table With Drip Stand*  
*Sürgü Çekmeceli, Çöp Kovalı*  
*Ayarlanabilir.*  
Kod: 25.70210.80



▲  
**Serum Askılı Cerrah Masası**  
*Operating Table With Drip Stand*  
*Tekerlekli, Hidrolik Ayaklı, Çöp Kovalı*  
Kod: 25.65210.90



▲  
**Müşahade Arabası**  
*Operating Equipments Trolley*  
*Serum Askılı*  
Kod: 25.45055.75

## “INOX” Sedyeler / Stretchers



◀ **Muayene Masası**  
Hospital Bed  
65x190x75 cm.  
Kod: 25.65190.75



▲ **Muayene Masası Sırtlıklı**  
Hospital Bed  
65x190x80 cm.  
Kod: 18.L2010.00



▲ **Oturak**  
Stool  
Kod: 18.L8008.00



▲ **Bebek Yatağı Komple P. Çelik**  
Baby Bed  
Yerden yatağa olan yükseklik: 53 cm.  
70x140x120 cm.  
Kod: 18.L2063.00



▲ **Paravan**  
Paravane  
22 mm. x 1.5 mm. Her bölüm 50x180 cm.  
Katlanmamış uzunluk: 200 cm. Renk: Yeşil, Mavi  
Kod: 18.L4600.00

## “INOX” Sedyeler / Stretchers



▲ **Hasta Taşıma Sedyesi**  
Stretcher  
Serum Askılı. Minderli.  
Korkuluklu. 65x190x80 cm.  
Kod: 24.06144.A0



▲ **Hasta Taşıma Sedyesi**  
Stretcher  
Açılır/kapanır korkuluklu. 55-105 cm.  
Yükseklik Ayarlı. 60x190x55/105 cm.  
Kod: 18.L2067.00



▲ **Hasta Taşıma Sedyesi**  
Stretcher  
Hareketli korkuluklar  
63x190x65 cm.  
Kod: 18.L2068.00



▲ **Hasta Taşıma Sedyesi**  
Stretcher  
Komple P. Çelik 190x57x55 cm.  
Açılır / Kapanır korkuluklu. Hareketli sırt tablası  
55-105 cm. yükseklik ayarlı  
Kod: 18.L2070.00



▲ **Jinekoloji Muayene Masası**  
Gynecology Bed  
Manuel sırt ayarlı. 55x190x80 cm.  
Kod: 18.L2013.00



▲ **Jinekoloji Muayene Masası**  
Gynecology Bed  
Ayarlı Tabla. 60x190x80 cm.  
Kod: 18.L2014.00

# “INOX” Sedyeler / Stretchers



## ◀ Hasta Taşıma Sedyesi

Stretcher

Açılır / Kapanır korkuluklu

Hareketli sırt, hareketli ayak tablası

Tekerlekli tabla haricinde

38-63 cm. yükseltme ayarı

67x206x55 cm.

**Kod: 18.L2069.C0**



## Hasta Taşıma Sedyesi ▶

Stretcher

Açılır / Kapanır korkuluklu

Hareketli sırt, hareketli ayak tablası

57x190x55/105 cm.

**Kod: 18.L2069.B0**



## ◀ Hasta Taşıma Sedyesi

Stretcher

Hareketli korkuluklar.

Hareketli sırt, hareketli ayak tablası

57x190x55/105 cm.

**Kod: 18.L2069.00**

## Hasta Transfer Sedyesi ▶

Transfer Stretcher



# INOX DOLAPLAR



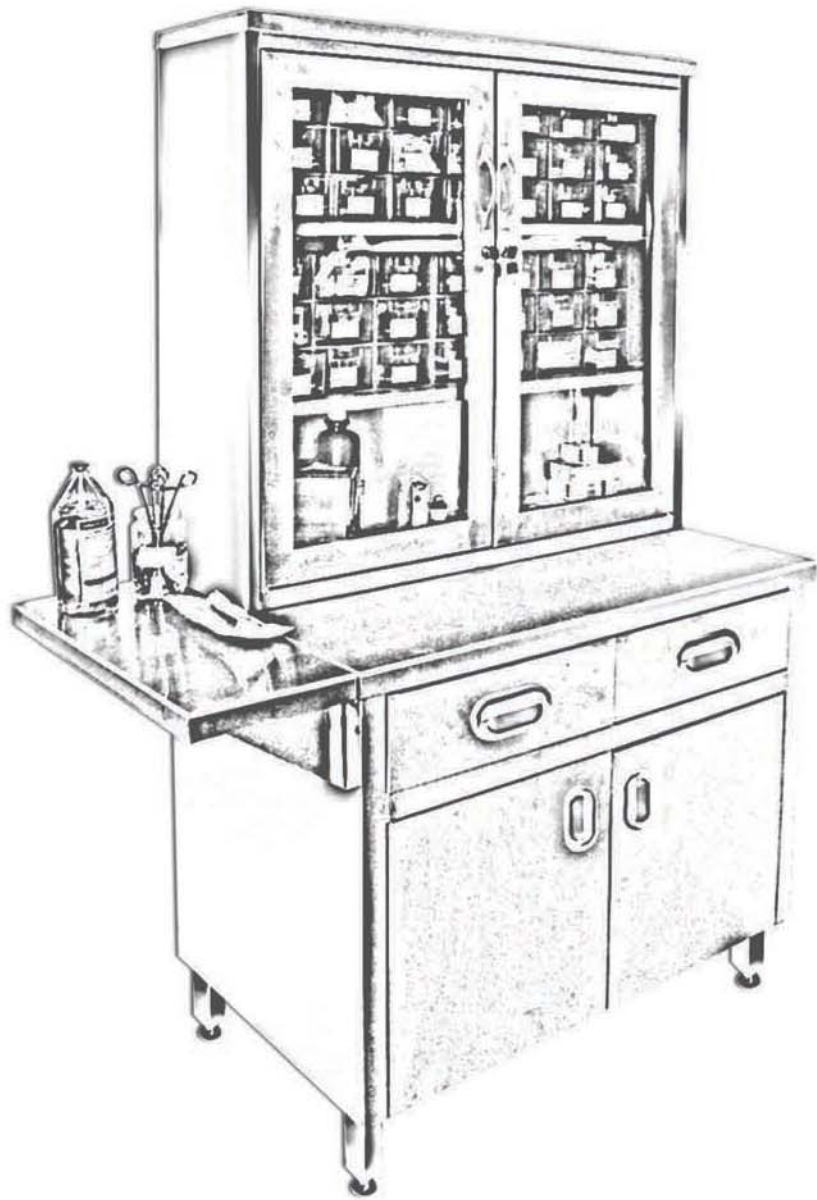

## “INOX” Medical Dolaplar / Cabinets



▲ **Alet/İlaç Dolabı**  
Pharmacy/Instrument Cabinet  
Dolaplı, çekmeceli.  
Üstte camlı vitrin.  
60x104x180 cm.  
**Kod: 02.D6010.18**



▲ **İlaç Dolabı**  
Pharmacy Cabinet  
Camlı, dört katlı kilitli  
ilaç dolabı. 50x100x180 cm.  
**Kod: 02.D5010.18**



▶ **Alet/İlaç Dolabı**  
Pharmacy/Instrument Cabinet  
Dolaplı, çekmeceli.  
Üstte camlı vitrin.  
Yanda bankolu.  
60x104x180 cm.  
**Kod: 02.D6010.19**

## “INOX” Medical Dolaplar / Cabinets



▲  
**Katater Dolabı**  
Catheter Cabinet  
60x110x190 cm.  
Kod No: 02.D6011.19



▲  
**Endoskopi Dolabı**  
Endoscopy Cabinet  
(4 endoskop kapasiteli)  
60x40x120 cm.  
Kod No: 02.D4060.21



◀  
**Branş Dolabı**  
Anesthetics Trolley  
Pansuman/Anestezi arabası.  
Stoplu tekerlekli.  
60x65x95 cm.  
(Çekmece ve kapak seçenekleri mevcut)  
Kod: 02.T6065.95



# “INOX” Dolap ve Çalışma Tezgahları / Cabinets & Counters



## ◀ Duvara Asma Yarım Dolap

Wall Mounted Small Cabinet

Çift kapaklı, iki raflı.

Kod	Ölçü
08.0904.00	40x90x60 cm.
08.1204.00	40x120x60 cm.
08.1404.00	40x140x60 cm.
08.1604.00	40x160x60 cm.
<u>08.1904.00</u>	<u>40x190x60 cm.</u>

## Duvara Asma Yarım Dolap ▶

Wall Mounted Small Cabinet

Çift kapaklı, iki raflı.

Sürgülü, menteşeli

Kod No: 08.1204.60



## ▶ Dolaplı Çalışma Tezgahı

Work Counter With Cabinet

Çift sürgü kapaklı, ara raflı.

Kod	Ölçü
08.12060.13	60x120x85 cm.
08.12070.13	70x120x85 cm.
08.14060.13	60x140x85 cm.
08.14070.13	70x140x85 cm.
08.16060.13	60x160x85 cm.
08.16070.13	70x160x85 cm.
08.19060.13	60x190x85 cm.
<u>08.19070.13</u>	<u>70x190x85 cm.</u>



## ▶ Dolaplı Çalışma Tezgahı

Work Counter With Cabinet

Çift sürgü kapaklı, ara raflı,  
gurup çekmeceli.

Kod	Ölçü
08.12060.56	60x120x85 cm.
08.12070.56	70x120x85 cm.
08.14060.56	60x140x85 cm.
08.14070.56	70x140x85 cm.
08.16060.56	60x160x85 cm.
08.16070.56	70x160x85 cm.
08.19060.56	60x190x85 cm.
08.19070.56	70x190x85 cm.
08.24060.56	60x240x85 cm.
<u>08.24070.56</u>	<u>70x240x85 cm.</u>



## “INOX” Arabalar / Trolleys



▲ **Pansuman Dolabı**  
Medication Trolley  
Tekerlekli.  
65x90x85 cm.  
Kod: 24.06590.85



▲ **Grup Çekmeceli Komedin (Koter Masası)**  
Cautery Trolley  
Üç çekmeceli. Tekerlekli.  
60x40x85 cm.  
Kod: 24.06129.00



▲ **Pansuman Arabası**  
Medication Trolley  
Alt tablalı, tek küvetli.  
55x75x85 cm.  
Kod: 25.05575.85



▲ **Pansuman Arabası**  
Medication Trolley  
Alt tablalı, çift küvetli.  
55x75x85 cm.  
Kod: 25.05575.90



▲ **Pansuman Arabası**  
Emergency Trolley  
Alt tablalı, çekmeceli.  
55x75x85 cm.  
Kod: 25.05575.80

## “INOX” Arabalar / Trolleys



▲  
**İlaç/Anestezi Arabası**  
Anesthetics/Medication Trolley  
Çekmeceli.  
50x70x105/170 cm.  
Kod: 02.T5070.17



▲  
**İlaç/Anestezi Arabası**  
Anesthetics/Medication Trolley  
Kapaklı ve çekmeceli.  
50x70x105/170 cm.  
Kod: 02.T5070.20



▲  
**İlaç/Anestezi Arabası**  
Anesthetics/Medication Trolley  
Kapaklı ve çekmeceli.  
50x70x105/170 cm.  
Kod: 02.T6070.21



▲  
**Pansuman Arabası**  
Emergency Trolley  
Tromelli, çift küvetli.  
50x90x90 cm.  
Kod: 25.05090.90



▲  
**Pansuman Arabası**  
Emergency Trolley  
Çekmeceli, küvet ve çöp kovası.  
Muhafazalı  
50x70x80 cm.  
Kod: 25.05070.85



▲  
**Pansuman Arabası**  
Emergency Trolley  
Çift çekmeceli, alt tablalı.  
Çöp kovası çemberli.  
Muhafazalı.  
Kod: 25.05075.80

## “INOX” Arabalar / Trolleys



▲ **Alet Masası**  
Surgical Instruments Table  
(Servis Arabası)  
Kod: 25.04080.10



▲ **Alet Masası**  
Surgical Instruments Table  
(Servis Arabası)  
Kod: 25.04035.10



▲ **Alet Masası Trolley**  
**(Bohça arabası)**  
(Servis Arabası)  
Kod: 25.05080.00



◀ **Alet Bohça Arabası**  
Trolley

**Kod** **Ölçü**  
25.04060.85 40x60x85 cm.  
25.05080.85 50x80x85 cm.  
25.06100.85 60x100x85 cm.

▲ **Alet Bohça Arabası Çekmeceli**  
Trolley (Drawer)  
**Kod** **Ölçü**  
25.04060.90 40x60x85 cm.  
25.05080.90 50x80x85 cm.  
25.06100.90 60x100x85 cm.



▲ **Servis Arabası / Service Trolley**  
Çöp kovalı.  
55x85x90 cm.  
Kod No: 25.05585.90



▲ **Servis Arabası**  
Service Trolley  
55x80x85 cm.  
**Kod**  
08.00507.01 İki Katlı  
08.00508.01 Üç Katlı  
08.00506.01 Dört Katlı

# “INOX” Hijyen Ekipmanlar / Hygienic Equipments



▲ **Hijyen Paspas**  
Hygienic Mat  
75x60 cm.  
Kod: 55.V7560.00



▲ **Hijyen Paspas**  
Hygienic Mat  
60x120 cm.  
Kod: 24.60120.00



▲ **Hijyen Paspas Tablası**  
Hygienic Mat Plate  
75x90 cm.  
Kod: 55.V7590.00

▲ **Galoşmatik**  
Automatic Shoe Cover Machine  
Otomatik galoş giyme aparatı.  
Kod: 65.Z1512.00



▲ **Galoş, Maske, Bone Dolabı**  
Mask, Bonnet, Shoe Cover Cabinet  
Boy Dolap.  
Alt kısmı atık bölümüdür.  
40x60x150 cm.  
Kod: 02.W4060.15



▲ **Galoş, Maske, Bone Dolabı**  
Mask, Bonnet, Shoe Cover Cabinet  
Tekerlekli Dolap.  
Alt kısmı atık bölümüdür.  
30x60x120 cm.  
Kod No: 02.W3060.12



▲ **Galoş, Maske, Bone Dolabı**  
Mask, Bonnet, Shoe Cover Cabinet  
Asma Dolap.  
Alt kısmı atık bölümüdür.  
25x50x80 cm.  
Kod No: 02.W2550.80

# “INOX” Kan Muhafaza Dolapları / Blood Refrigerators



## ◀ Defrost Sistemli Kan Muhafaza Dolabı

*Blood Bank Refrigerator*

*Hermetik kompresör*

*64x73x114.5 cm.*

*180 Lt.*

*2°-6° C.*

*Kod: 25.BR300.00*



## ◀ Defrost Sistemli Kan Muhafaza Dolabı

*Blood Bank Refrigerator*

*Hermetik kompresör*

*64x73x157 cm.*

*320 Lt.*

*2°-6° C.*

*Kod: 25.BR500.00*

# “INOX” Kan Muhafaza Dolapları / Blood Refrigerators



◀ **Plazma Kan Muhafaza Dolabı**  
*Blood Plasma Preservation Cabinet*  
2°-6° C.  
Kod: 25.02030.00

**Defrost Sistemli Kan Muhafaza Dolabı** ▶  
*Blood Bank Refrigerator*  
74x80x195 cm.  
600 Lt.  
2°-6° C.  
Kod: 25.07480.19



**Defrost Sistemli Kan Muhafaza Dolabı** ▶  
*Blood Bank Refrigerator*  
150x80x195 cm.  
1350 Lt.  
2°-6° C.  
Kod: 25.15080.19



## “INOX” Morg Dolapları / Mortuary Cabinets



### ▲ Morg Dolabı

Mortuary Cabinet

Yandan kapaklı ve girişli.

Kod	Ölçü
25.90220.20	İki Katlı 90x220x200 cm.
25.90220.25	Üç Katlı 90x220x250 cm.



### Morg Dolabı ▲

Mortuary Cabinet

Önden kapaklı ve girişli.

İki katlı.

95x230x200 cm.

Kod No: 25.95230.20



*INOX RAF*  
&  
*SERVİS SİSTEMLERİ*



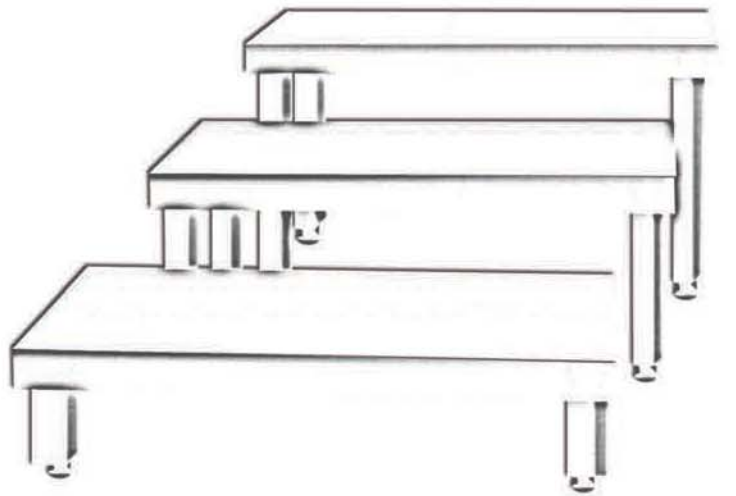
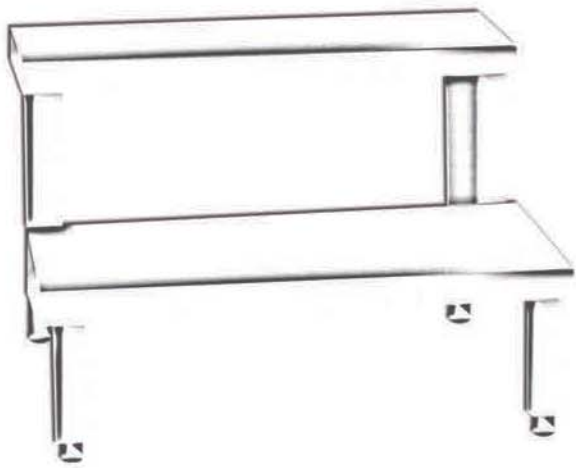

## “INOX” Raf ve Basamaklar / Rack & Steps

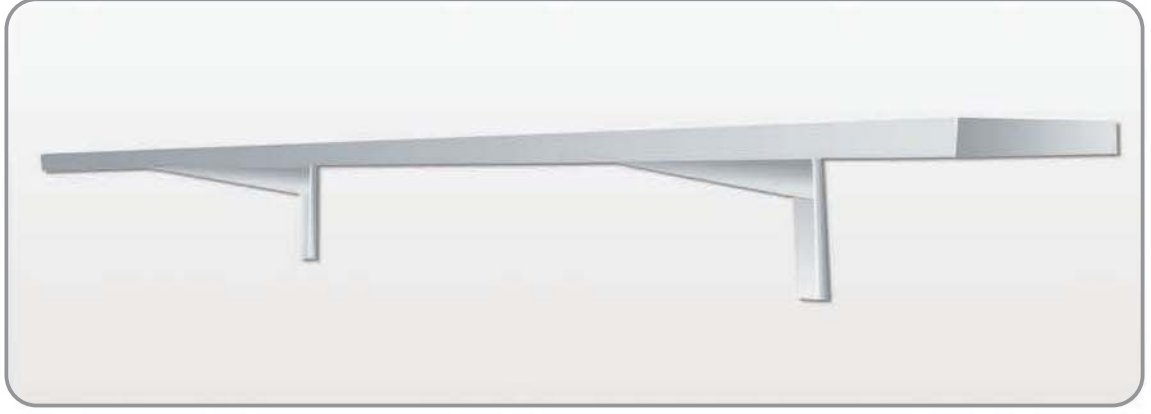

**Duvar Rafi** ▲  
Wall Rack

<i>Kod</i>	<i>Ölçü</i>
08.10030.30	30X100X4 cm.
08.12030.30	30x120x4 cm.
08.14030.30	30x140x4 cm.
08.16030.30	30x160x4 cm.
<u>08.19030.30</u>	<u>30x190x4 cm.</u>



**▲ İki Basamak (ESKABO)**

Steps  
Ameliyathaneler İçin

<i>Kod</i>	<i>Ölçü</i>
08.W6530.44	Dar Basamak 30x65x22/44 cm.
<u>08.W6560.44</u>	<u>Geniş Basamak</u> <u>60x65x88/44 cm.</u>



**▲ Tekli Basamak (ESKABO)**

Step  
Ameliyathaneler İçin

<i>Kod</i>	<i>Ölçü</i>
08.W6035.12	Alçak: 35x60x12 cm.
08.W6035.18	Orta: 35x60x22 cm.
08.W6035.22	Yüksek: 35x60x30 cm.
<u>08.W6560.20</u>	<u>Büyük: 60x65x20 cm.</u>



# “INOX” Raf Sistemleri / Shelving Systems



▲  
**Terlik Taşıma Arabası**  
6 Katlı  
53.5x10x18.5 cm.  
Kod: 09.10055.20

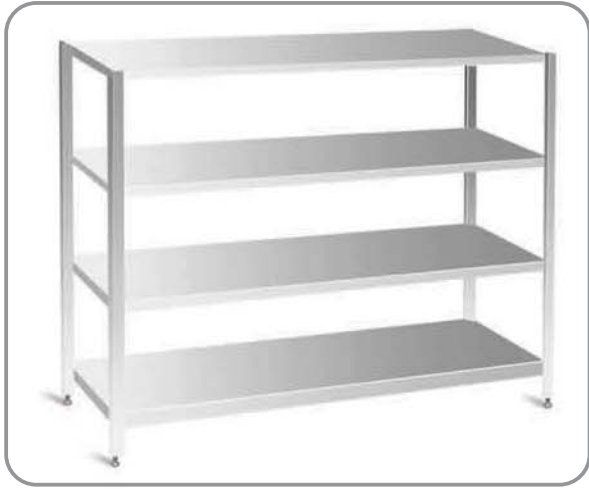

**4 KATLI İSTİF RAFI**  
4 LAYER SHELVING  
(Düz Raf)  
A= 50 cm.  
B= .... cm.  
H= 155 cm.

B= 90 cm.	09.50090.15
B= 120 cm.	09.50120.15
B= 140 cm.	09.50140.15
B= 160 cm.	09.50160.15
B= 190 cm.	09.50190.15

Kod

**4 KATLI İSTİF RAFI**  
4 LAYER SHELVING  
(Düz Raf)  
A= 60 cm.  
B= .... cm.  
H= 155 cm.

B= 90 cm.	09.60090.15
B= 120 cm.	09.60120.15
B= 140 cm.	09.60140.15
B= 160 cm.	09.60160.15
B= 190 cm.	09.60190.15

**4 KATLI İSTİF RAFI**  
4 LAYER SHELVING  
(Düz Raf)  
A= 70 cm.  
B= .... cm.  
H= 155 cm.

B= 90 cm.	09.70090.15
B= 120 cm.	09.70120.15
B= 140 cm.	09.70140.15
B= 160 cm.	09.70160.15
B= 190 cm.	09.70190.15

**4 KATLI İSTİF RAFI**  
4 LAYER SHELVING  
(Düz Raf)  
A= 80 cm.  
B= .... cm.  
H= 155 cm.

B= 90 cm.	09.80090.15
B= 120 cm.	09.80120.15
B= 140 cm.	09.80140.15
B= 160 cm.	09.80160.15
B= 190 cm.	09.80190.15

**4 KATLI İSTİF RAFI**  
4 LAYER SHELVING  
(2 Düz, 2 Izgaralı Raf)  
A= 50 cm.  
B= .... cm.  
H= 155 cm.

B= 90 cm.	09.09050.40
B= 120 cm.	09.12050.40
B= 140 cm.	09.14050.40
B= 160 cm.	09.16050.40
B= 190 cm.	09.19050.40

**4 KATLI İSTİF RAFI**  
4 LAYER SHELVING  
(2 Düz, 2 Izgaralı Raf)  
A= 60 cm.  
B= .... cm.  
H= 155 cm.

B= 90 cm.	09.09060.40
B= 120 cm.	09.12060.40
B= 140 cm.	09.14060.40
B= 160 cm.	09.16060.40
B= 190 cm.	09.19060.40

**4 KATLI İSTİF RAFI**  
4 LAYER SHELVING  
(2 Düz, 2 Izgaralı Raf)  
A= 70 cm.  
B= .... cm.  
H= 155 cm.

B= 90 cm.	09.09070.40
B= 120 cm.	09.12070.40
B= 140 cm.	09.14070.40
B= 160 cm.	09.16070.40
B= 190 cm.	09.19070.40

**4 KATLI İSTİF RAFI**  
4 LAYER SHELVING  
(2 Düz, 2 Izgaralı Raf)  
A= 80 cm.  
B= .... cm.  
H= 155 cm.

B= 90 cm.	09.09080.40
B= 120 cm.	09.12080.40
B= 140 cm.	09.14080.40
B= 160 cm.	09.16080.40
B= 190 cm.	09.19080.40

# “INOX” Demonte Raf Sistemleri / Shelving Systems

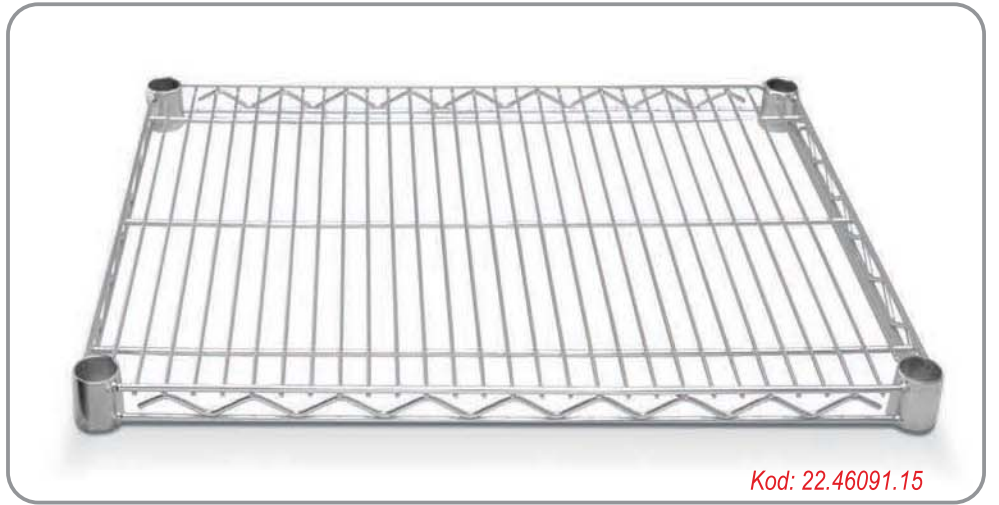

Kod: 22.46091.15

## 3 KATLI RAF

3 LAYER SHELVING  
(Demonte Izgara Rafli)

A= 46 cm.

B= .... cm.

H= 150 cm.

B= 91 cm.

B= 107 cm.

B= 122 cm.

B= 137 cm.

B= 152 cm.

B= 183 cm.

Kod

22.46091.15

22.46107.15

22.46122.15

22.46137.15

22.46152.15

22.46183.15

## 3 KATLI RAF

3 LAYER SHELVING  
(Demonte Izgara Rafli)

A= 53 cm.

B= .... cm.

H= 150 cm.

B= 91 cm.

B= 107 cm.

B= 122 cm.

B= 137 cm.

B= 152 cm.

B= 183 cm.

22.53091.15

22.53107.15

22.53122.15

22.53137.15

22.53152.15

22.53183.15

## 3 KATLI RAF

3 LAYER SHELVING  
(Demonte Izgara Rafli)

A= 61 cm.

B= .... cm.

H= 150 cm.

B= 91 cm.

B= 107 cm.

B= 122 cm.

B= 137 cm.

B= 152 cm.

B= 183 cm.

22.61091.15

22.61107.15

22.61122.15

22.61137.15

22.61152.15

22.61183.15

## 4 KATLI RAF

4 LAYER SHELVING  
(Demonte Izgara Rafli)

A= 46 cm.

B= .... cm.

H= 183 cm.

B= 91 cm.

B= 107 cm.

B= 122 cm.

B= 137 cm.

B= 152 cm.

B= 183 cm.

22.46091.18

22.46107.18

22.46122.18

22.46137.18

22.46152.18

22.46183.18

## 4 KATLI RAF

4 LAYER SHELVING  
(Demonte Izgara Rafli)

A= 53 cm.

B= .... cm.

H= 183 cm.

B= 91 cm.

B= 107 cm.

B= 122 cm.

B= 137 cm.

B= 152 cm.

B= 183 cm.

22.53091.18

22.53107.18

22.53122.18

22.53137.18

22.53152.18

22.53183.18

## 4 KATLI RAF

4 LAYER SHELVING  
(Demonte Izgara Rafli)

A= 61 cm.

B= .... cm.

H= 183 cm.

B= 91 cm.

B= 107 cm.

B= 122 cm.

B= 137 cm.

B= 152 cm.

B= 183 cm.

22.61091.18

22.61107.18

22.61122.18

22.61137.18

22.61152.18

22.61183.18

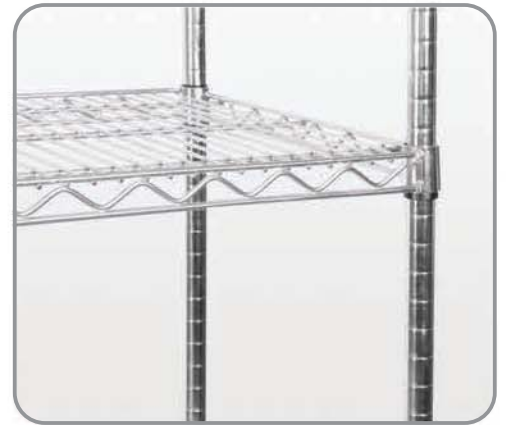
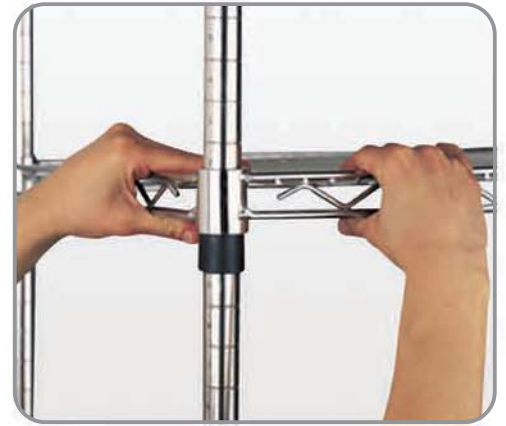

## “INOX” Taşıma Sistemleri / Moving Trolleys



▲ **Konteynır Taşıma Arabası**  
Container Moving Trolley  
Açık  
70x115x130 cm.  
Kod: 02.D7011.13



▲ **Konteynır Taşıma Arabası**  
Container Moving Trolley  
Kapalı  
63x105x130 cm.  
Kod: 02.D6311.13



▲ **Küvet Taşıma Arabası**  
Bowl Trolley  
Kod: 24.6S146.00



▲ **Termo Tepsi Taşıma Arabası**  
Thermo Plate Trolley  
10 Katlı  
60x45x165 cm.  
Kod: 09.D6045.16



▲ **Termo Tepsi Taşıma Arabası**  
Thermo Plate Trolley  
20 Katlı  
60x90x165 cm.  
Kod: 09.D6090.16

# Thermotrans Taşıma Kapları / Boxes, Caps & Trays



Muhtelif dizayn ve ebatlarda Thermotrans Taşıma Kapları



Thermotrans Organ Nakil Çantası



Taşıma Kasaları  
(Muhtelif dizayn ve ebatlarda)  
Moving Cases

**Termo Tepsi** ▶  
Thermotrans Tray  
Yarım Kapaklı  
5 Gözlü  
37x52x12 cm.  
Kod: 01.OOT50.00



**Termo Tepsi** ▶  
Thermotrans Tray  
Tam Kapaklı  
5 Gözlü  
37x52x12 cm.  
Kod: 01.OT100.05



▲ **Termo Tepsi** 38x53x10 cm.  
Thermotrans Tray  
Tam Kapaklı 6 Gözlü  
Kod: 01.OT100.00



## ◀ Servis Tepsisi

Service Tray  
5 Gözlü "TH"  
40x28 cm.

Kod: 01.04028.01



## ◀ Yemek Taşıma Kabı (Tabansız)

Carrying Pot

Kod	Ölçü	
02.02415.10	6.5 lt.	24x15 cm.
02.02424.10	10.5 lt.	24x24 cm.
02.02824.10	14.5 lt.	28x24 cm.
02.03028.10	20.0 lt.	30x28 cm.
02.03032.10	22.0 lt.	30x32 cm.
02.03636.10	36.0 lt.	36x36 cm.
02.04040.10	50.0 lt.	40x40 cm.
02.05050.10	88.0 lt.	50x50 cm.



## ◀ Yemek Taşıma Kabı (Tabanlı)

Carrying Pot

Kod	Ölçü	
02.02415.20	6.5 lt.	24x15 cm.
02.02424.20	10.5 lt.	24x24 cm.
02.02824.20	14.5 lt.	28x24 cm.
02.03028.20	20.0 lt.	30x28 cm.
02.03032.20	22.0 lt.	30x32 cm.
02.03636.20	36.0 lt.	36x36 cm.
02.04040.20	50.0 lt.	40x40 cm.
02.05050.20	88.0 lt.	50x50 cm.



## ◀ Yemek Termosu (Tencereli)

Carrying Pot

Kod	Ölçü	
02.03247.01	30.0 lt.	32x47 cm.

## ◀ Yemek Termosu

Carrying Pot

Kod	Ölçü	
02.03247.02	30.0 lt.	32x47 cm.



*DISPENSERLER  
&  
ARMATÜRLER*



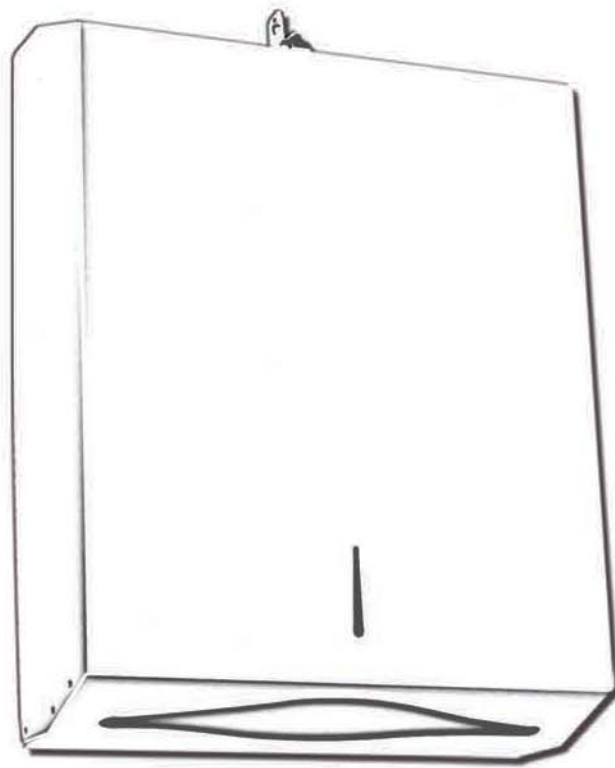

## Sterilizasyon / Sterilization



▲  
**Hava Dezenfektan Makinesi**  
*Air Disinfectant Machine*

P.çelik gövde  
Formaldehid ve  
Amonium neutrolizasyon  
Kod: 12.Y1800.00



▲  
**Hava Dezenfektan Makinesi**  
*Air Disinfectant Machine*

Kod: 12.Y0900.00



▲  
**Kuru Hava Steril Makinesi**  
*Dry Air Sterilization Machine*

55 Litre. 1600 Watt.  
P.çelik iç gövde, iki çelik raflı.  
Kuru hava ile sterilizasyon yapar.  
Zaman ayarlı. 100° - 200° C.  
55x55x70 cm.  
Kod: 12.Y1600.00



**Trommel** ▶  
*Trommel*

Kod	Ölçü
12.75015.00	Ø 15x15 cm.
12.75019.00	Ø 15x19 cm.
12.75024.00	Ø 24x24 cm.
12.75029.00	Ø 24x29 cm.
12.75032.00	Ø 24x32 cm.
12.75039.00	Ø 24x39 cm.

P.çelik.  
Kuru hava  
sterilizasyonuna uygun.  
Kapaklı.

## Dezenfektan Ürünleri / Disinfection Unit



▲ **STERIJET Fotoselli**  
**Ayak Dezenfektan Ünitesi**  
STERIJET Feet Disinfection Unit  
29x18x103 cm.  
2000 cc. dezenfektan kapasitesi  
220 V. 50/60 Hz.  
12 V. Çalışma, 40 W. Güç  
**Kod: 12.Y0500.00**



▲ **QuickWash**  
**El/Ayak Dezenfektan Ünitesi**  
QuickWash Hand/Feet Disinfection Unit  
41x37x108 cm.  
5 Litre kapasiteli.  
220 V. 50/60 Hz.  
24 V. Çalışma, 70 W. Güç  
**Kod: 12.Y0400.00**



▲ **Fotoselli Sprey**  
**Dezenfektan Ünitesi**  
Disinfection Spray Unit  
2100 ml. ABS, Göstergeli  
AC: 220 V. / DC 6 V.  
**Kod: 16.EX210.00**



▲ **STERIHAND**  
**El Dezenfektan Ünitesi**  
STERIHAND Hand Disinfection Unit  
27x22x40.5 cm.  
1000 cc. dezenfektan kapasiteli  
12 V. Girişli şarj edilebilir.  
Veya 220 V. Girişli.  
20 W. güç  
**Kod: 12.Y0200.00**



▲ **STERIPLUS**  
**El Dezenfektan Ünitesi**  
STERIPLUS Hand Disinfection Unit  
30x20x63 cm.  
2000 cc. dezenfektan kapasiteli  
220 V. 50/60 Hz. giriş.  
Seyyar için ayak takabilme olanağı  
20 W. güç  
**Kod: 12.Y0300.00**

# Sabun Dispenserleri / Soap & Foam Dispensers



▲ **Fotoselli Paslanmaz Çelik Sıvı Sabun Dispenseri**  
Liquid Soap Dispenser  
1200 ml. Parlak, Göstergeli  
Dezenfektan Kullanımına Uygun  
4x AA Kalem PİL 6, 0V.  
Kod: 16.EX120.00



▲ **Sıvı Sabun Dispenseri**  
Liquid Soap Dispenser  
820 ml. Kilitli  
Parlak, Basmalı, Duvara Monte  
Dezenfektan Kullanımına Uygun  
Kod: 16.EX082.00



▲ **Fotoselli Sıvı Sabun Dispenseri**  
Liquid Soap Dispenser  
2100 ml. ABS Göstergeli  
Dezenfektan Kullanımına Uygun  
AC: 220 V. / DC 6 V  
Kod: 16.EX210.10



▲ **ABS Sıvı Sabunluk**  
ABS Liquid Soap Dispenser  
42.S9277.00 - 900 ml.  
Beyaz/Şeffaf - Krom/Şeffaf  
42.S9273.00 - 1400 ml.  
Beyaz/Şeffaf - Krom/Şeffaf  
Kod: 42.S9277.00



▲ **Fotoselli Sıvı Sabunluk**  
Liquid Soap Dispenser  
800 ml. ABS Kilitli Gövde  
Dezenfektan Kullanımına Uygun  
150.000 Kullanımlık PİL Ömrü  
4x AA Pille Çalışır  
Kod: 16.EX080.00



▲ **Fotoselli Köpük Sabun Dispenseri**  
Foam Soap Dispenser  
ABS Krom  
1100 ml. Kilitli  
A Kalem PİL ile Çalışır  
Kod: 12.S0411.00



▲ **Köpük Sabun Dispenseri**  
Foam Dispenser  
Beyaz - 42.S3480.00  
ABS Krome - 42.S3484.00  
Kod: 42.S3484.00



▲ **Sıvı Sabun Dispenseri**  
Liquid Soap Dispenser  
Dikey/Yatay 1100 ml. Kilitli  
Saten, Duvara Monte  
Kod: 17.E0923.00



▲ **Tezgaha Monte 1000 ml. Sıvı Sabunluk ve Köpük Sabunluk**  
Liquid Soap & Foam Dispenser  
Counter Mounted  
Kod: 17.E0628.00

## Kağıt Dispenserleri / Paper Dispenser



▲ **Kağıt Havlu Dispenser**  
Paper Towel Dispenser  
P.Ç. Saten, Kilitli  
500 Kağıt  
Kod: 52.D0928.00



▲ **Tuvalet Kağıdı Dispenser**  
Toilet Paper Dispenser  
P.Ç. Jumbo - Kilitli  
Kod: 54.D0925.00



▲ **Tuvalet Kağıtlığı**  
Toilet Paper Dispenser  
05.D0914.11 - Tekli,  
Tam kapaklı, Kilitli  
05.D0924.11 - Çiftli,  
Tam kapaklı, Kilitli  
Kod: 05.D0924.11



▲ **Kağıt Havlu Dispenser**  
Paper Towel Dispenser  
41.D0920.00 - P.Ç. Saten,  
Kilitli, 500 Kağıt  
Kod: 32.D0920.00



▲ **Klozet Kapağı Dispenser**  
Seat Cover Dispenser  
Paslanmaz Çelik, Aplike  
Kod: 32.D0880.00



▲ **Kağıt Havlu Dispenser**  
Paper Towel Dispenser  
075 cm. Aplike/Ankastre  
Tek Kapaklı, Kilitli  
30x75x12/14 cm  
Kod: 05.D0751.00



▲ **Kağıt Havlu Dispenser**  
Paper Towel Dispenser  
125 cm. Aplike/Ankastre  
Tek Kapaklı, Kilitli  
35x125x12/14 cm  
Kod: 05.D1251.00



▲ **Kağıt Havlu Dispenser**  
Paper Towel Dispenser  
140 cm. Aplike/Ankastre  
Tek Kapaklı, Çift Kilitli  
30x140x12/14 cm  
Kod: 05.D1401.00

## El/Yüz/Saç Kurutma Makineleri / Dryer Machines



▲  
**Çelik Gövdeli  
El Kurutma Makinesi**

Hand Dryer  
250 Watt. Uzun Ömürlü,  
Enerji Tasarrufu.  
Motor. 270 m<sup>3</sup>/saat. 6,0 Kg.  
**Kod: 16.P250A.00**



▲  
**Çelik Gövdeli  
El Kurutma Makinesi**

Hand Dryer  
2500 Watt. 360° Döner Kafalı.  
Uzun Ömürlü, Enerji Tasarruflu Motor.  
270m<sup>3</sup>/saat. 6,0 Kg.  
**Kod: 16.P250B.00**



▲  
**El Kurutma Makinesi**

Hand Dryer  
Beyaz Renkli Alüminyum Gövde.  
1600 Watt. Su Geçirmez.  
Sessiz, Güçlü, Uzun Ömürlü Motor.  
160m<sup>3</sup>/saat. 3,4 Kg.  
**Kod: 16.P2000.00**



▲  
**Saç Kurutma Makinesi**

Hair Dryer  
Silikon Spiral Kablolu.  
Asma Yuvalı.  
Sürgülü Kapak İçinde;  
Işıklı Açma Kapama  
Düğmesi ve 110/220 V.  
Emniyet Taş Prizli.  
1200 Watt. 71m<sup>3</sup>/saat  
**Kod: 16.12018.A0**



▲  
**Hortumlu Saç Kurutma Makinesi**

Hair Dryer  
110/220 V. Su Geçirmez Taş Prizli.  
5 Isı (40°/80°) Ayaralı.  
Dijital LCD Ekran.  
1500 Watt. 77,0 m<sup>3</sup>/saat.  
Sessiz Motor.  
Otomatik Kapanma.  
**Kod: 16.15015.00**



## Fotoselli Musluklar / Automatic Taps



▲  
**SILFRA**  
**Fotoselli Lavabo Musluğu**  
Automatic Sensor Tap  
Tek veya Çift Su Girişli.  
Elektrikli/Pilli.  
Kod: 14.QT220.00



▲  
**Fotoselli**  
**Pilli Rezervuar Musluğu**  
Sensor Cistern Tap  
Kod: 19.LB301.30



▲  
**Fotoselli**  
**Ankastre Rezervuar Otomatığı**  
Automatic Sensor Cistern Tap  
Tek Giriş, Tek Çıkışlı.  
Elektrikli, Pilli.  
Kod: 19.TW.204.AB



▲  
**Fotoselli**  
**Aplike Rezervuar Musluğu**  
Automatic Sensor Cistern Tap  
Pilli.  
Kod: 19.LB301.20



## Fotoselli Musluklar / Automatic Taps



▲ **Fotoselli Lavabo Musluğu**  
Automatic Sensor Basin Tap  
Çift Su Girişli.  
Full Otomatik Isı Kontrolü.  
Pilli.  
Kod: 19.LL306.00



▲ **Fotoselli Lavabo Musluğu**  
Automatic Sensor Basin Tap  
Tek Su Girişli.  
Elektrikli/Pilli.  
Kod: 19.LL302.00



▲ **Fotoselli Lavabo Musluğu**  
Automatic Sensor Basin Tap  
Çift Su Girişli.  
Manuel Isı Kontrolü.  
Pilli.  
Kod: 19.LL602.00



▲ **Fotoselli Lavabo Musluğu**  
Automatic Sensor Sink Tap  
Tek Su Girişli.  
Full Otomatik Isı Kontrolü.  
Elektrikli/Pilli.  
Kod: 19.LT203.00



▲ **Fotoselli Ankastre Musluk Seti**  
Automatic Sensor Basin Tap  
Tek Su Girişli.  
Pilli.  
Kod: 19.LY304.00



▲ **Fotoselli Aplike Musluk**  
Automatic Sensor Basin Tap  
Tek Su Girişli.  
Pilli.  
Kod: 19.LY303.00

## Pedallı Musluk Sistemleri / Pedal Taps



▲  
**Tek Su Girişli,  
Tek Pedallı Musluk**  
Single Water Entry Pedal Tap  
Yerden - 43.K2061.00  
Duvardan - 43.K2064.00  
Kod: 43.K2061.00



▲  
**Sıcak/Soğuk Çift Su Girişli  
Tek Pedallı Musluk**  
Hot/Cold Double Water Entry  
Pedal Tap  
Yerden - 43.K2070.00  
Duvardan - 43.K2072.00  
Kod: 43.K2070.00



▲  
**Sıcak/Soğuk Çift Su Girişli  
Çift Pedallı Musluk**  
Hot/Cold Double Water Entry  
Two Pedal Tap  
Kod: 44.K2066.00



▲  
**Sıcak/Soğuk Su Mikseri**  
Hot/Cold Water Mixer  
Kod: 44.KS950.00



▲  
**Pedallı Musluk Çıkış Ucu**  
Tap Out  
Tezgahtan  
Kod: 43.K4200.00



▲  
**Pedallı Musluk Çıkış Ucu**  
Tap Out  
Duvardan  
Kod: 43.K4100.00

*INOX AKSESUAR*

*&*

*KOVA*



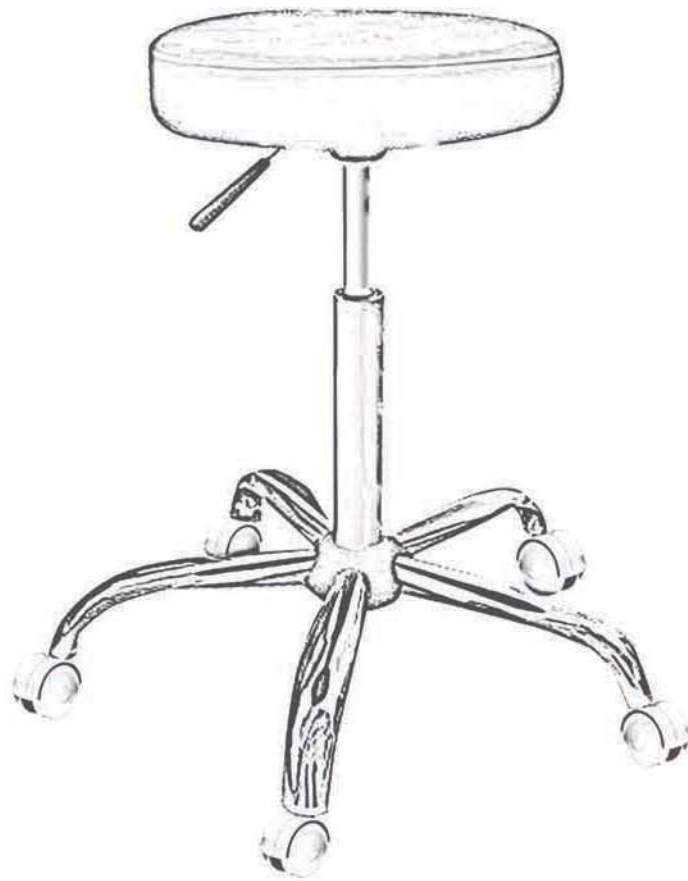

## “INOX” Aksesuarlar / Accessories



▲  
**Böbrek Küvetleri**  
Kidney Bowl

**Kod** **Ölçü**  
10.K0025.00 Küçük 25 cm.  
10.K0030.00 Büyük 30 cm.



▲  
**Kapaklı Küvet**  
Bowl With Cover

Paslanmaz Çelik.  
Çift Kilitli Sistem.  
**Kod** **Ölçü**  
10.K1828.05 Küçük  
10.K2232.05 Büyük



▲  
**Alet Kutusu**  
Tool Box

**Kod** **Ölçü**  
10.K1428.07 14x28x7 cm.  
10.K2424.07 24x24x7 cm.  
10.K2424.10 24x24x10 cm.  
10.K4848.08 48x48x8 cm.



▲  
**Alet Kutusu**  
Tool Box  
Delikli, Kapaklı.

**Kod** **Ölçü**  
10.K2830.08 28x30x8 cm.  
10.K2848.10 28x48x10 cm.  
10.K2848.15 28x48x15 cm.



▲  
**Gastronom Küvet**  
Gastronomic Bowl  
Delikli.

**Kod** **Ölçü**  
10.K3253.10 32x53x10 cm.  
10.K3253.15 32x53x15 cm.  
10.K3253.20 32x53x20 cm.



▲  
**Küvet**  
Bowl

**Kod** **Ölçü**  
10.K3253.30 32x53x10 cm.  
10.K3253.35 32x53x15 cm.  
10.K3253.40 32x53x20 cm.



▲  
**Alet Kutusu / Tool Box**  
Paslanmaz Çelik.  
Çift Kilitli Sistemli kapak.

**Kod** **Ölçü**  
10.K1222.06 12x22x6 cm.  
10.K1822.05 18x22x5 cm.  
10.K1828.07 14x28x7 cm.  
10.K2033.05 20x33x5 cm.  
10.K1634.08 16x34x8 cm.  
10K.1840.09 18x40x9 cm.  
10K.2050.10 20x50x10 cm.

# “INOX” Ameliyathane Aksesuarları / Operating Accessories



◀ **Cerrahi Küvet Ayaklığı**  
Instrument Stand With Bowl  
Tekerlekli, Tek Ayaklı.  
26x53x120 cm.  
Kod: 02.X2653.12



▲ **Hidrolik Mayo Masası**  
Hydraulic Mayo Table  
Antistatik, Tekerlekli.  
53x85x85/125 cm.  
Kod: 02.X5385.85



◀ **Cerrahi Küvet Ayaklığı**  
Instrument Stand With Bowls  
Tekerlekli, Tek Ayaklı,  
İkili.  
26x53x120 cm.  
Kod: 02.X2653.80



▲ **Mayo/Enstrüman Masası**  
Over Bed Tables

Elden Hidrolikli, Manual Ayarlı  
**Kod Ölçü**  
02.X5080.85 50x80x85 cm.

Ayaktan Hidrolikli, Yüksek Boy Model.  
**Kod Ölçü**  
02.5080.90 50x80x90 cm.



◀ **Cerrahi Küvet Ayaklığı**  
Instrument Stand With Bowls  
Çıkarılabilir küvet.  
Tekerlekli, İkili.  
29x53x85 cm.  
Kod: 02.X2953.85

## “INOX” Serum Askıları / Drip Stands

### Serum Askısı

Drip Stand

Paslanmaz Çelik.

4 Adet Plastik Serum Kancalı.

5 Tekerlekli Plastik Ayaklı.

Ayarlanabilir Yükseklik.

23x23x80 cm.

Kod: 02.X2670.80



### Ameliyathane Serum Askısı

Drip Stand

135/200 cm.

(4 Ayaklı)

Kod: 02.X2680.80



### Ameliyathane Serum Askısı

Drip Stand

135/200 cm.

(5 Ayaklı)

Kod: 02.X2690.80



Kol Sehpası / Arm Trestle

Kod: 02.40020.80

## “INOX” Tabureler / Chairs



### ◀ Ameliyathane Taburesi

Surgeon's Chair  
P. Çelik Oturma Grubu  
35 cm.

Kod: 10.T7020.00



### ◀ Ameliyathane Taburesi

Surgeon's Chair  
Ayaktan Hidrolikli.  
Kromaj Ayaklı.  
48x63x60 cm.

Kod: 10.T7022.00



### ◀ Ameliyathane Taburesi

Surgeon's Chair  
Poliüretan Oturma Grubu  
60x74x33 cm.

Kod: 10.T7021.00



# “INOX” Ayna Sistemleri / Mirror Systems



◀ **Engelli Aynası**  
Angled Mirror  
Hareketli  
40x60 cm.  
Kod: 34.F3530.00

**Engelli Aynası** ▶  
Angled Mirror

Kod	Ölçü
34.F0530.00	50x70 cm.
34.F0540.00	60x80 cm.



◀ **Çerçevesiz Ayna**  
Framed Mirror  
50x60 cm.  
Kod: 34.F5060.00

**Vandal Ayna** ▶

Vandal Mirror  
60x80 cm.  
Kod: 02.F6080.00



◀ **Dolaplı Ayna**  
Cabinet With Mirror  
40x12x30 cm.  
Kod: 64.F2807.28

**Dolaplı Ayna** ▶

Cabinet With Mirror  
38x11x56 cm.  
Kod: 48.F8103.00



## “INOX” Engelli Aksesuarları / Disabled Accessories



◀ **Engelli Yer/Duvar Tutunma Barı**  
Floor/Wall Holding Bar  
Ø 3.2 cm. 75x75 cm.  
Kod: 34.F0503.00



▲ **Engelli “L” Bar.**  
Holding Bar 90 °  
(Yatay Kısmı Sağda/Solda)  
Ø 3.2 cm. 80x40 cm.  
Kod: 34.F0502.00



◀ **Engelli WC Tutunma Barı**  
Safety Holding Bar (Mobile)  
Ø 3.2 cm. 75 cm.  
Kod: 34.F0504.00



▲ **Engelli WC Tutunma Barı**  
Reversible Holding Bar  
Sabit, Destekli.  
Ø 3.2 cm. 75 cm.  
Kod: 34.F0504.30



◀ **Engelli Arabası**  
Wheel Chair  
Paslanmaz Çelik  
Kod: 18.F0100.00

# “INOX” Engelli Aksesuarları / Disabled Accessories

## Engelli Duş Küvet Oturağı ▶

Shower/Bath Seat

Duvara Monte

40x40 cm.

Kod: 24.F0510.00

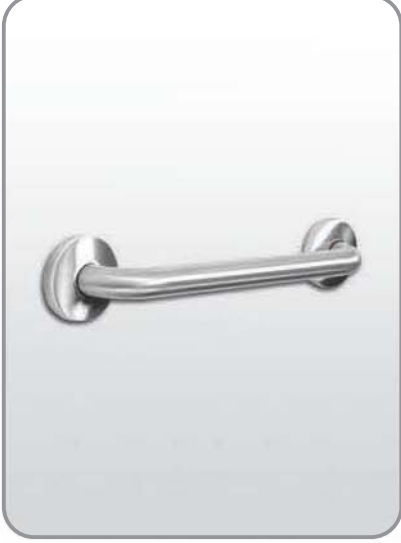

## ◀ Yatay/Dikey Düz Bar.

Horizontal, Vertical Holding Bar

Ø 3.2 cm. 60 cm.

Kod: 34.F0500.06

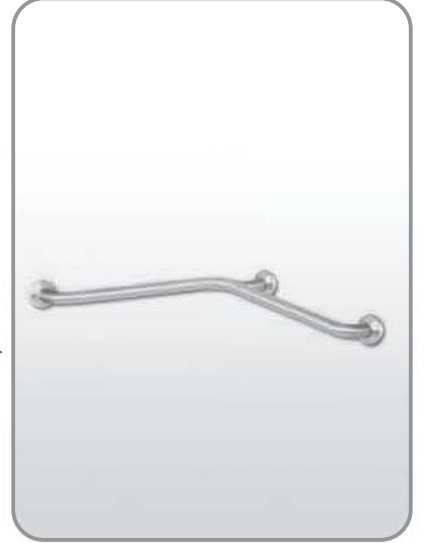

## Köşe Tutunma Barı ▶

Side Holding Bar

Ø 3.2 cm.

60x80 cm.

Kod: 34.F0505.00



## ◀ Yatay/Dikey Düz Bar

Horizontal, Vertical Holding Bar

Ø 3.2 cm. 100 cm.

Kod: 34.F0500.00



## Açılı Tutunma Barı ▶

Angled Holding Bar

Ø 3.2 cm. 60 cm.

Kod: 34.F0501.00

# “INOX” Çöp Kovaları / Waste Bins



◀ **Dikdörtgen Yandan Pedallı Kova**  
“Rectangle” Side Pedalled Bin

Patentli Ürün / Patented Product

Kod	Ölçü
10.HK424.02	07 Lt. 24x10x30 cm.
10.HK430.02	23 Lt. 30x15x50 cm.
10.HK440.02	40 Lt. 40x20x50 cm.



▲ **Hijyen Torba Dispanseri Gözlü, Önden Kapaklı Çöp Kovası. Kilitli.**  
Bin With Hygienic Tissue Dispenser

Kod	Ölçü
10.H3012.45	10. Lt İç Kovalı 20x20x35 cm.
10.H3014.60	16 Lt. İç Kovalı 30x14x60 cm.



◀ **Sallanır Çatı Kapaklı Çöp Kovaları**  
Swinging Roof Lid Bin

(AISI 304 Kalite 0,80-1,00 mm.  
Paslanmaz Çelik Modelleri Vardır).

Kod	Ölçü
32.HK435.00	14 Lt. 20x20x35 cm.
32.HK450.00	30 Lt. 25x25x50 cm.
32.HK470.00	70 Lt. 35x35x60 cm.



▲ **Dikdörtgen Kova**  
Rectangular Bin

P.Çelik 304 Kalite Duvara Monte  
veya Bağımsız.

Kod	Ölçü
10.HK424.00	07 Lt. 24x10x30 cm.
10.HK430.00	23 Lt. 30x15x50 cm.



◀ **Dikdörtgen Kova Kapaklı**  
Rectangular Bin With Lid

P.Çelik 304 Kalite Duvara Monte  
veya Bağımsız.

Kod	Ölçü
10.HK424.20	07 Lt. 24x10x30 cm.
10.HK430.20	23 Lt. 30x15x50 cm.

## “INOX” Tekerlekli Kovalar / Waste Bins



**Tıbbi Atık Arabası** / Medical Waste Trolley

P.Çelik. Üstten iki Kapaklı.  
İki Taraftan İtme Saplı.  
4 Tekerlekli 2'si Frenli.  
127x65x100 cm.

**Kod: 02.W6512.20**

### Ameliyathane Çöp Kovası

Mobile Waste Bin  
Darbelere Karşı  
P.Çelik Çember Korumalı  
Ø 36x36 cm.  
**Kod: 02.W3636.10**



### Ameliyathane Atık Kovası

Mobile Waste Bin  
P. Çelik. Kapaklı ve Taşıma  
Saplı. Darbelere Karşı  
Plastik Çember Korumalı.

Kod	Ölçü
02.W4540.00	Ø 45x40 cm.
02.W5555.00	Ø 55x55 cm.



### Malzeme Taşıma Arabası

Supply Trolley  
84x54x58 cm.

**Kod: 22.MT142.00**

### Endüstriyel Pedallı Çöp Kovası

Industrial Waste Bin With Pedal  
Tekerlekli, komple açılır kapaklı.  
AISI 304 kalite 0. 80 mm.

Kod	Ölçü
31.HK080.00	55 lt. Ø 40x50 cm.
31.HK090.00	80 lt. Ø 40x65 cm.
02.W5555.00	100 lt. Ø 40x90 cm.



## “INOX” Tekerlekli Arabalar / Trolleys



◀ **Tel Sepet Arabası**  
Basket Trolleys  
Kod: 24W0110.60



▲ **Malzeme Arabası**  
Instrument Trolleys  
43x64x68 cm.  
Kod: 02.64436.80



◀ **Malzeme ve Atık Arabası**  
Instrument/Waste Bag Trolley  
Kod: 02.W7090.70



◀ **Malzeme Arabası**  
Supply Trolley  
50x50x80 cm.  
Kod: 02.50505.80

# “INOX” Torbalı Arabalar / Trolleys



**RUBBERMAID Çöp Torbalı  
Tekerlekli Atık Arabası**  
Waste Bag Trolley With Wheels  
Kod: 11.R6300.00



**Pedallı Çöp Torbası Aparatı**  
Pedaled Waste Bag Apparatus  
Kod: 02.W4045.80



**Çamaşır Arabası**  
Laundry Trolley  
(Klipsli, Çiftli).  
45x110x90 cm.  
Kod: 02.W4511.90



**Çamaşır Arabası**  
Laundry Trolley  
(Klipsli, Tekli).  
45x50x90 cm.  
Kod: 02.W4550.90









Fabrika / Factory





**OZTI MEDİKAL & SANİTAR ÜRÜNLERİ HİZMETLERİ  
SAN. VE TİC. A. Ş.**

Cumhuriyet Mah. Eski Hadımköy Yolu  
No: 31/3 Büyükçekmece - İstanbul  
Tel.: 0212. 886 65 72 - 73  
Fax: 0212. 886 78 21  
[ozti@sanitar.com.tr](mailto:ozti@sanitar.com.tr)

**Taahhüt Koordinatörlüğü**

Bahariye Cad. No: 60  
Kasımpaşa - İstanbul  
Tel.: 0212. 297 19 04 - 05  
Fax: 0212. 297 19 10

**Ankara Bölge Müdürlüğü**

Turan Güneş Bulvarı 91. Sok.  
No: 9/17-18 Çankaya - Ankara  
Tel.: 0312. 440 11 00 (Pbx)  
Fax: 0312. 440 81 18

**Antalya Bölge Müdürlüğü**

Organize Sanayi Bölgesi  
2. Cadde Antalya  
Tel.: 0242. 312 32 39 - 40  
Fax: 0242. 312 22 53

**İzmir Bölge Müdürlüğü**

Akçay Caddesi Ali Mütevellioğlu  
İş Merkezi No: 9/4  
Gaziemir - İzmir  
Tel.: 0232. 265 54 54 (Pbx)  
Fax: 0232. 265 31 29